

# F-Theta f=160mm

## Drawing No. SH-1064-110-160-20

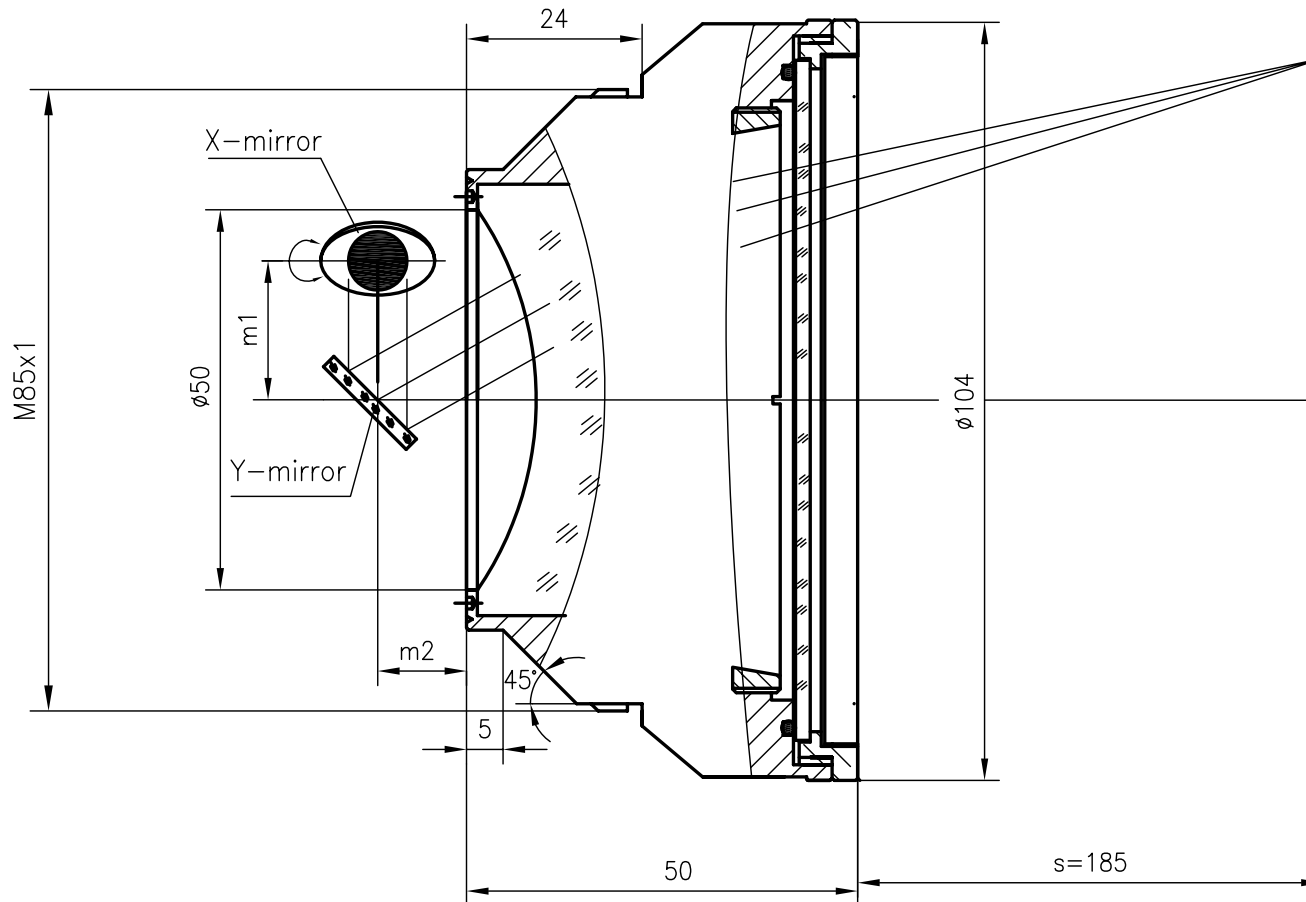

### Specification

EFL	160mm
S	185mm
Wavelength	$\lambda = 1064\text{nm}$
scan angle	$\pm 28^\circ$
max scan field	110mm x 110mm
Entrance beam diameter $\varnothing$	20mm
Center point diameter ( $1/e^2$ )	17 $\mu\text{m}$
Edge point diameter ( $1/e^2$ )	19 $\mu\text{m}$
mirror distance m1	18
mirror distance m2	24
Transmission >	97%
Thread	M85x1
With protective window	yes