

# F-Theta f=330mm

## Drawing No. SH-1064-220-330-20

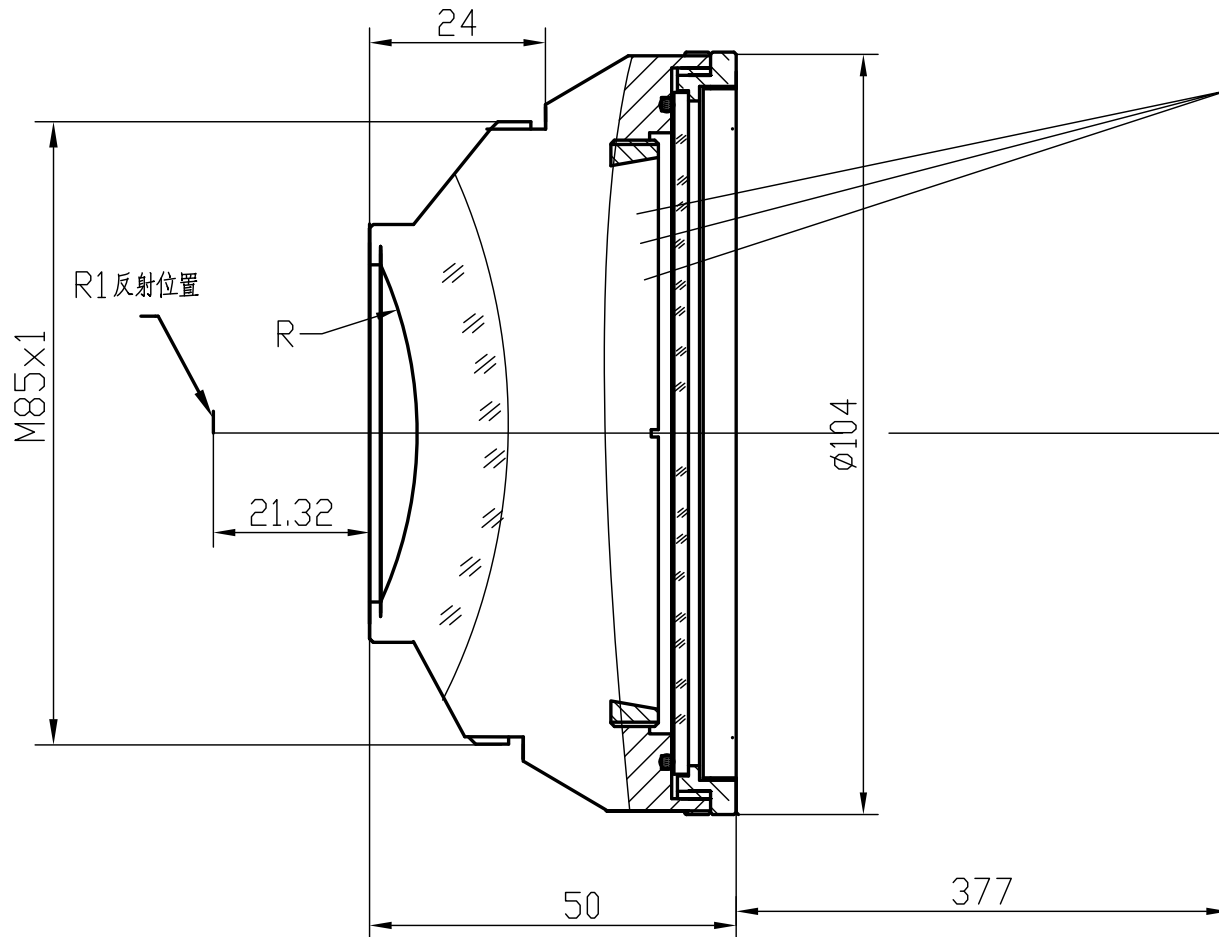

### Specification

EFL	330mm
S	477mm
Wavelength	$\lambda = 1064\text{nm}$
scan angle	$\pm 28^\circ$
max scan field	220mm x 220mm
Entrance beam diameter $\varnothing$	20mm
Center point diameter ( $1/e^2$ )	33 $\mu\text{m}$
Edge point diameter ( $1/e^2$ )	35 $\mu\text{m}$
mirror distance m1	18
mirror distance m2	16
Transmission >	97%
Thread	M85x1
With protective window	yes