

F-Theta f=650mm

Drawing No. SH-355-400-650-8

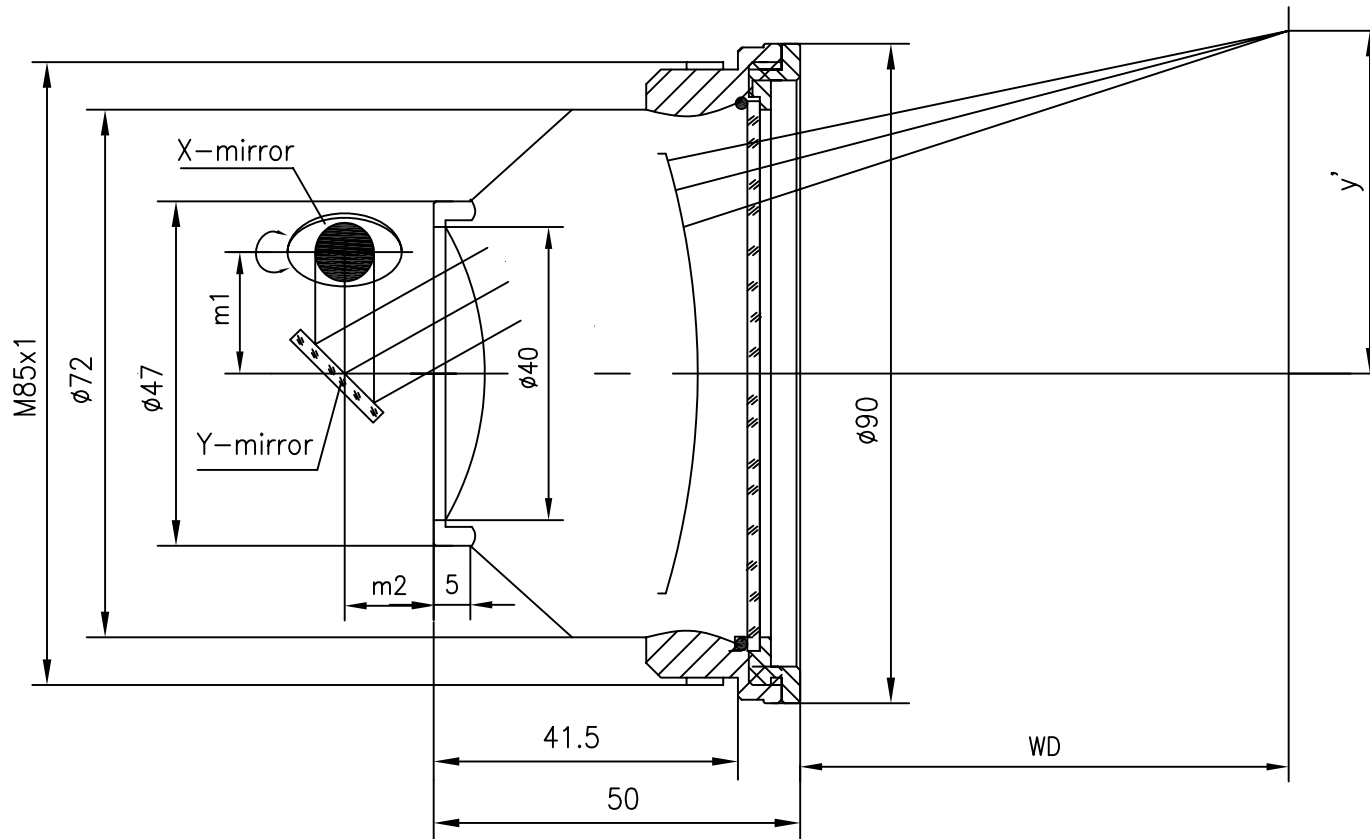

Specification

EFL	650mm
WD	710mm
Wavelength	$\lambda = 355\text{nm}$
scan angle	$\pm 28^\circ$
max scan field	400mm x 400mm
Entrance beam diameter ϕ	8mm
Center point diameter ($1/e^2$)	53 μm
Edge point diameter ($1/e^2$)	65 μm
mirror distance m1	12-20
mirror distance m2	12-20
Transmission >	97%
Thread	M85x1
With protective window	yes