

F-Theta f=254mm D10mm for clean

Drawing No. SH-CL-1064-180-254-10-FS

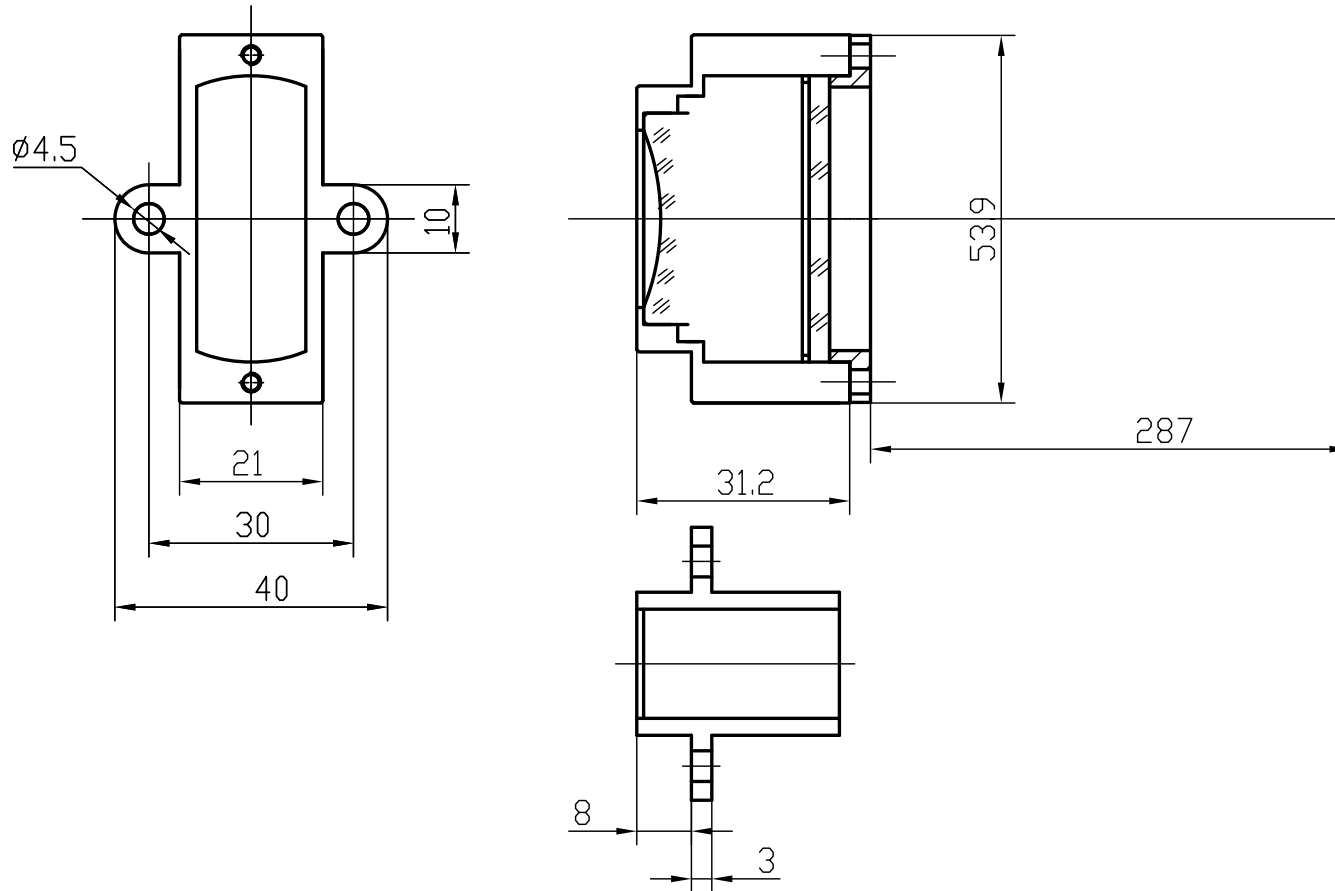

**Specification**

EFL	254mm
S	287mm
Wavelength	$\lambda = 1064\text{nm}$
scan angle	$\pm 27^\circ$
max scan length	180mm
Entrance beam diameter $\phi$	10mm
Center point diameter ( $1/e^2$ )	50 $\mu\text{m}$
Edge point diameter ( $1/e^2$ )	52 $\mu\text{m}$
mirror distance m1	
mirror distance m2	10-12
Transmission >	97%
Thread	
With protective window	yes